

CSP180/300

Conduction-cooled capacitor

Technology Patented Worldwide

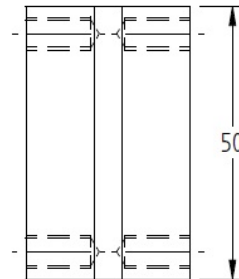
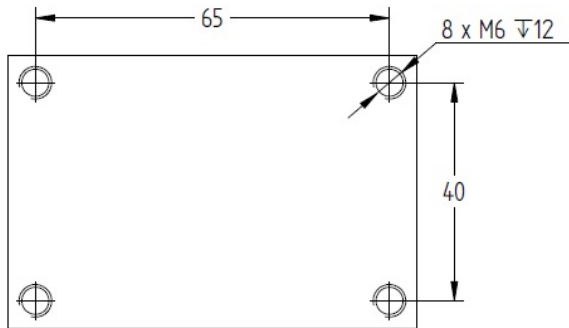
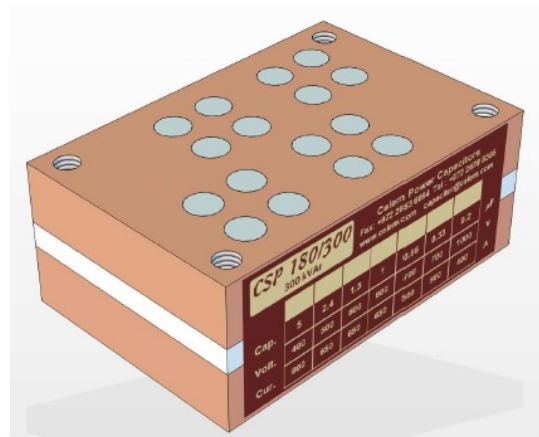
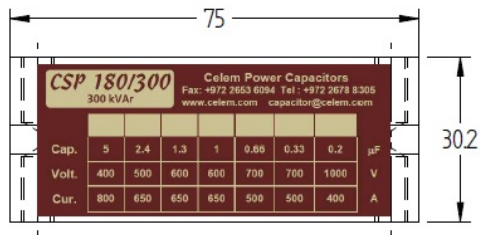

The new CSP 180/300 conduction-cooled capacitor is a 300kVAr version of the 180kVAr CSP 180. It can be mounted only between 2 parallel plates.

Specifications

Type		CSP180/300							
Dimensions (L x W x H)	mm	75 x 50 x 30.2							
Weight	kg	0.5							
Capacitance ($\pm 10\%$)	μF	0.1 μF	0.2 μF	0.33 μF	0.66 μF	1 μF	1.3 μF	2.6 μF	5 μF
Sinusoidal Voltage	V _{rms}	1000		700		600		500	400
Peak Voltage	V	1410		990		850		710	570
Max. Current	A _{rms}	350	400	500		650		800	
Max. Power	kVA _r	300							
Freq Range @ Full Power	kHz	477-650	239-424	295-402	148-201	133-224	102-172	73-86	60-68
Stray Inductance	nH	<5							

Celem Power Capacitors

Produced: 03-09-2015

CSP180/300

Conduction-cooled capacitor

Technology Patented Worldwide

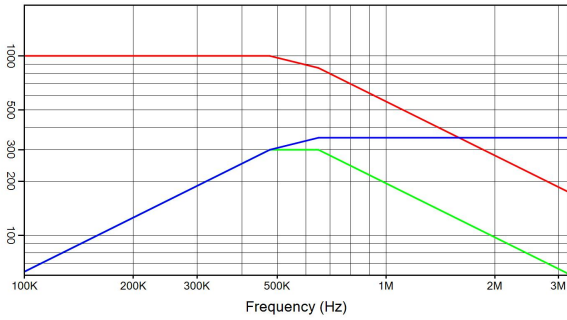

CSP180/300 0.1 μF 1000 V_{rms} 350 A_{rms} 300 kVA_r
 I(A) — Q(kVA_r) — V_{rms}

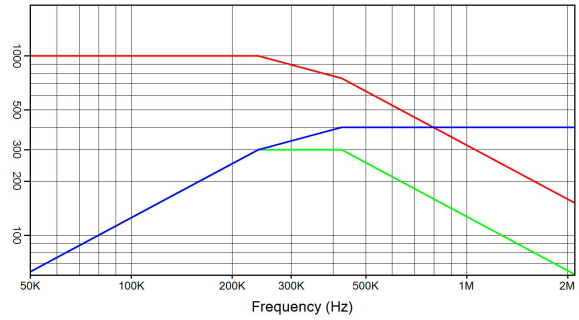

CSP180/300 0.2 μF 1000 V_{rms} 400 A_{rms} 300 kVA_r
 I(A) — Q(kVA_r) — V_{rms}

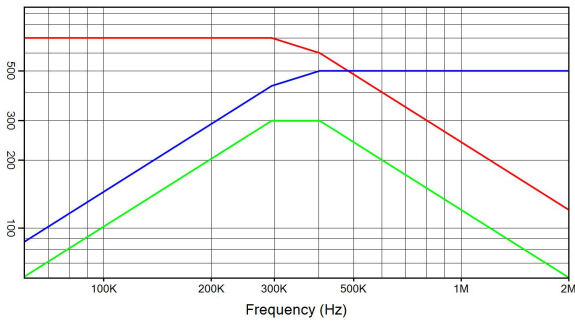

CSP180/300 0.33 μF 700 V_{rms} 500 A_{rms} 300 kVA_r
 I(A) — Q(kVA_r) — V_{rms}

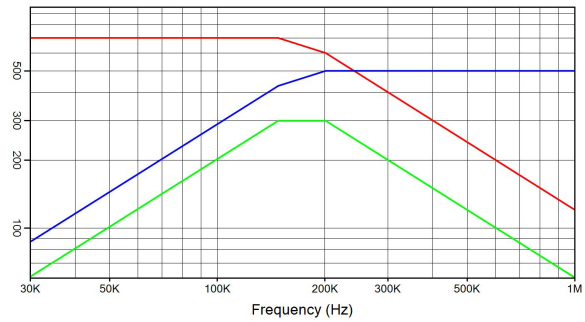

CSP180/300 0.66 μF 700 V_{rms} 500 A_{rms} 300 kVA_r
 I(A) — Q(kVA_r) — V_{rms}

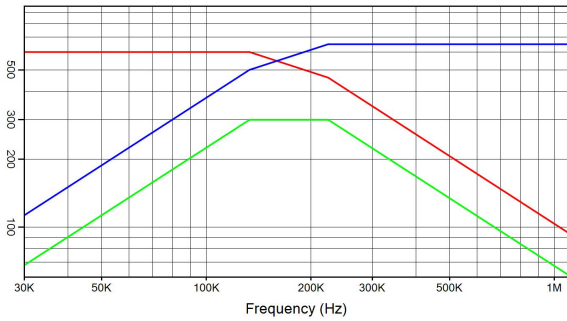

CSP180/300 1 μF 600 V_{rms} 650 A_{rms} 300 kVA_r
 I(A) — Q(kVA_r) — V_{rms}

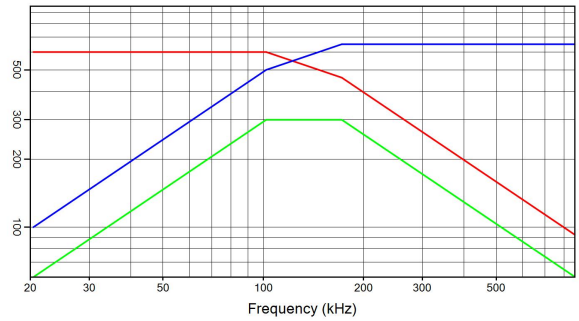

CSP180/300 1.3 μF 600 V_{rms} 650 A_{rms} 300 kVA_r
 I(A) — Q(kVA_r) — V_{rms}

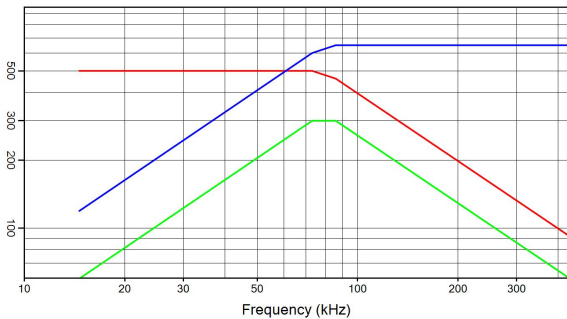

CSP180/300 2.6 μF 500 V_{rms} 650 A_{rms} 300 kVA_r
 I(A) — Q(kVA_r) — V_{rms}

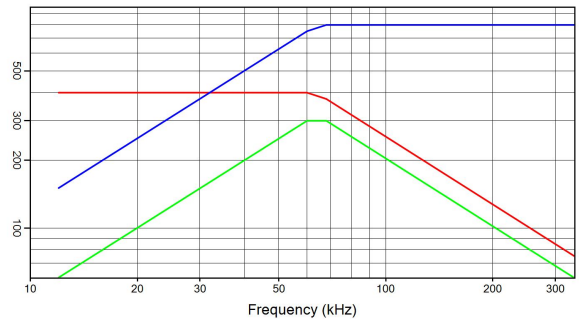

CSP180/300 5 μF 400 V_{rms} 800 A_{rms} 300 kVA_r
 I(A) — Q(kVA_r) — V_{rms}

Celem Power Capacitors